

AN OFDM Platform for Wireless Systems Testing: Alamouti 2x1 MIMO example

¹MANUEL VIOLAS, ²JOÃO LOURENÇO, ¹ADÃO SILVA, ¹ATÍLIO GAMEIRO

¹DETI, Instituto de Telecomunicações, ²Instituto de Telecomunicações

University of Aveiro

Campus Universitário de Santiago 3810-193 Aveiro

PORTUGAL

manuelv@ua.pt, joao.lourenco@av.it.pt, asilva@av.it.pt, and amg@ua.pt

Abstract: - In this paper, we present a real-time implementation of an OFDM hardware platform. The platform is based on HW blocks that can be put together to configure a wireless system based on OFDM modulation. The platform can be easily upgraded to test pre-coding cooperation algorithms. We evaluate the platform to implement a diversity Alamouti 2×1 MIMO scheme wireless system. The testbed is implemented using Field-Programmable Gate Array (FPGAs) through Xilinx System Generator for DSP. Blocks for time-domain synchronization and channel estimation are key components necessary in transmission system that require good time synchronization and channel estimation for efficient demodulation.

Key-Words: OFDM; FPGA; Software Defined Radio (SDR), CFO, LTE

1 Introduction

Wireless systems are one of the key components for enabling the information society. To meet the service requirements of future multimedia applications, Orthogonal Frequency Division Multiplexing (OFDM) is being adopted in various kinds of broadband wireless systems [1], namely the LTE standard [2].

It is commonly agreed that the provision of the broadband wireless component will rely on the use of multiple antennas at transmitter/receiver side. Multiple-input, multiple-output (MIMO) wireless communications are effective at mitigating the channel fading and thus improving the cellular system capacity. By configuring multiple antennas at both the base station (BS) and user terminal (UT), the channel capacity may be improved proportionally to the minimum number of the antennas at the transmitter and receiver [3].

MIMO systems are used to achieve diversity or/and multiplexing gains and both techniques are considered in the LTE. This paper focuses on the diversity based techniques. Space-time/frequency coding schemes, such as space-time block coding (STBC) or space-frequency block coding (SFBC), relying on multiple antennas at the transmitter side and appropriate signal processing at the receiver were proposed in [4][5]. The combination of STBC/SFBC with OFDM and SU equalizers at the receiver was considered in [6]. This combination was already adopted in the LTE.

Several testbeds for OFDM systems based on SDR have been reported on literature. For example in [7] it is presented an OFDM modulator/demodulator with two synchronization options and two error-controlling techniques. The work in [8] uses GNU radio to transfer OFDM signals with QPSK and BPSK modulation to analyze the packet-received ratio for Quality of Service purposes. Other broadly adopted research platform is WARP [9]. The work in [10] uses this testbed to present an OFDM-based cooperative system using Alamouti's block code to study its capability versus a 2 x 1 multiple input single output system. FPGA implementations of standards 802.11a and 802.16-2004' modulators using Xilinx System Generator for DSP for high level design can be found in [11][12]. Channel propagation is also a field where testbeds can have a relevant role[13] in models validation.

Implementation of communication standards such as LTE have also been reported [14]

We present a SDR transceiver that can be reconfigured to implement pre-precoding and post-coding algorithm schemes. The platform includes SISO baseband reconfigurable OFDM transceiver, which interfaces with an RF unit to up/down convert to the RF transmission frequency. For demonstration purpose we implemented the Alamouti techniques.

On the receiver side it should be able of achieve frame synchronization and estimate clock frequency

offset as well as channel estimation and provide channel equalization. The channel information is required for pre or pos-processing algorithms.

Two critical parts of the receiver are the synchronization and channel estimation subsystems. The synchronization should estimate the frame arrival time and a frequency offset between the local oscillator and RF carrier. Compensation can then be applied to the incoming signal. Unlike IEEE 802.11a/g and 802.16 (WiMAX), among others, this system does not use a training sequence to achieve time-domain synchronization.[xxxx]

An OFDM symbol, in frequency domain, each carrier should not only carry codified data but also control information. The transmitted value of a pilot carrier in the OFDM symbol is value is known by the receiver and allow for channel estimation. To make the system reconfigurable we codify the carrier's sequence of an OFDM symbol according to the type of information they carry: data, zeros and pilots.

In [13] we reported a SISO OFDM real-time chain based on LTE parameters. In this paper we extend this chain to include the two transmitting antennas in the transmitter side. In the reference receiver only the blocks required for demodulating and decoding the baseband signal were required to be developed.

The aim of this paper is to present the implementation of an FPGA-based OFDM reconfigurable transceiver with a with an OFDM transmitter and a receiver which implements ML time-domain synchronization algorithm, CFO correction, channel estimation and ZF channel equalization, using Xilinx System Generator for DSP

The system presented was built using a high-level design tool built into Matlab's Simulink, Xilinx System Generator for DSP, providing the user with high-level abstractions of the system that can be automatically compiled into an FPGA.

Work presented here is divided as follows: Section 2 presents the orthogonal frequency division multiplexing transceiver implemented in FPGA and some of its reconfigurable features; Section 3 presents a description of the upgrade made in the SISO OFDM architecture in order to convert it into a MISO OFDM system capable of implementing the Alamouti coding scheme algorithm; Section 4 presents the testbed platform used and how simulations were performed and Section V shows some of the validating results and explains the simulation results. Conclusions are provided on Section 4

2 The orthogonal frequency division multiplexing transceiver

In this section we briefly present the basic OFDM transceiver developed for single input single output antenna. The transceiver was developed as a starting platform to be updated in order to investigate cooperative antennas algorithms

2.1 Transmitter

The block diagram for the OFDM SISO transceiver discussed in this paper is depicted Fig. 1 and shows the main blocks for a standard OFDM transceiver with M-QAM modulation format.

One characteristic of the transmitter is that it should be flexible enough to assemble OFDM symbols in which the allocation of data and pilots to the subcarrier is mapped in a codifying vector. This way a finite set of vectors representing OFDM symbol types.

For instance a symbol used for synchronization; another symbol can have pilots together with data and another symbols type have only data carriers.

In Fig.2 we show how we implement this flexible feature in our system. The ROM contains the addresses (or IFFT feeding order) of the frequency carriers that are being generated and is organized as a matrix. Columns represent addresses and OFDM symbols. Columns represent subcarrier index type of subcarrier. In each address besides the frequency index the ROM codifies the type of content for that specific carrier, data, pilots or zero. The least significant 10 bits contains the index for the frequency carrier (memory address) in the OFDM symbol. Two multiplexers M1 and M2 are responsible for the sequence how data, pilots and zeros is placed in an OFDM symbol. Depending on the type of the OFDM symbol, M1 selects a two bits from out of 4 bits in column in the matrix. Band guards and DC are filled with zeros.

$$\begin{bmatrix} [b_{13}b_{12}] & [b_{11}b_{10}] & [b_9b_8 \dots b_2b_1b_0] \\ [Data] & [data - or - Pil] & [address - OFDM] \end{bmatrix} \quad (1)$$

The column selected according to the sequence of symbols type in the frame and stored in symbols type register. The output of M1 controls M2

responsible to multiplex the data, pilots and zeros in the right sequence to fill the symbol memory.

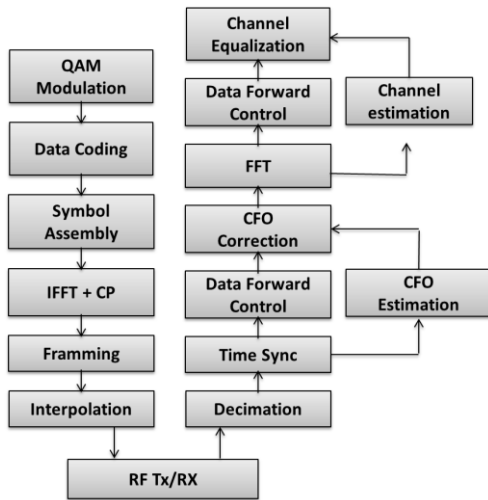

Fig. 1: Generic baseband OFDM transceiver.

This block allows changing easily the symbol and frame sequence to accommodate different type of test symbols. Pre-coding data blocks that operate in the data symbols can be included and synchronized with this block.

On the transmitter, data is generated randomly by making an inverse fast Fourier transform (IFFT) of quadrature amplitude modulated (QAM) symbol sets with 1024 subcarriers. The CP is added after the IFFT and the OFDM symbols are combined in sequence to build a frame.

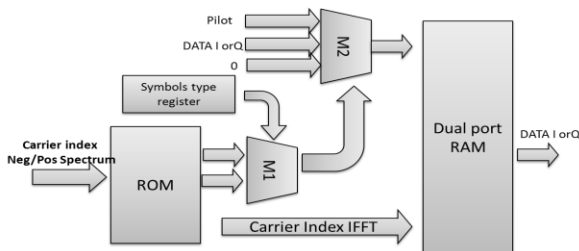

Fig.2: OFDM symbols assembly block diagram.

2.2 Receiver

The functions that a receiver has to perform are more complex than the transmitter ones. They include the frame start detection and time synchronization as well as control and correction of

any carrier frequency offset. In the next sections we will present how that functions were implemented in our platform.

2.2.1 Time-domain synchronization

Receiver and transmitter operate with independent local reference oscillators. In order to perform an efficient demodulation, the receiver should be able to perform frame and carrier synchronization. The first operation defines the starting / ending points of the frame while the latter synchronizes the phase / frequency between transmitter and receiver. Erroneous frame detection is projected into the symbol constellation with a circular rotation, whereas the carrier frequency offset (CFO) causes all the subcarriers to shift and is projected as dispersion in the constellation points. Both ambiguities yield the received signal:

$$r(k) = s(k - \tau) e^{j2\pi \epsilon k / N} + n(k) \quad (2)$$

where ϵ is the normalized CFO, τ is the unknown arrival time of a frame, $s(k)$ is the transmitted signal, N is the number of samples per symbol, $n(k)$ is the additive white gaussian noise (AWGN) and k is the sample index of each symbol ranging [0,1023].

Moose [15] presented a simple method using the CP just like Beek [16]. Schmidl and Cox [17] use the repetition on the preamble, providing a more robust algorithm for symbol formats where the CP is short.

We make use of preamble repetition on our system, together with the use of Zadoff-Chu (ZC) sequences at the beginning of each frame for time-domain synchronization due to its good autocorrelation properties and given that they are a part of 3GPP Long Term Evolution (LTE) air interface. Beek's algorithm, see Figure 3, was the chosen one due its lower complexity and it can be easily adapted to take advantage of our ZC sequences.

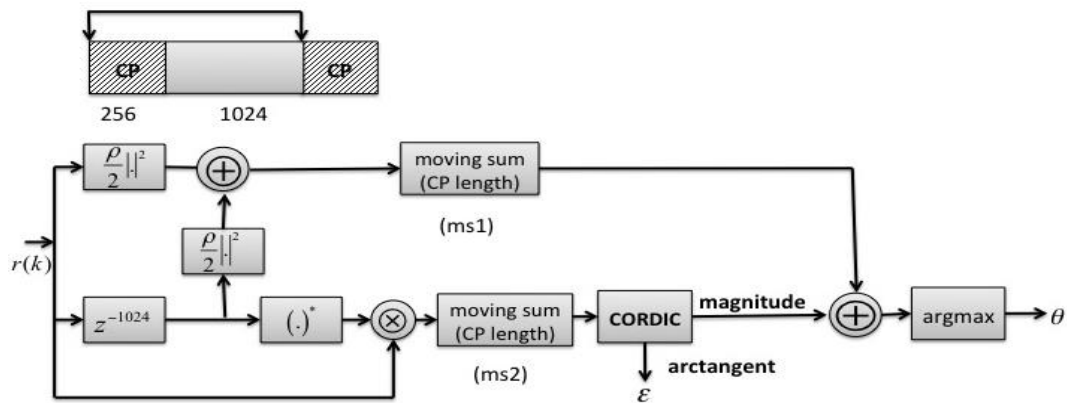

Fig. 3.: Beek estimation, Frame synchronization and CFO compensation

The following subsections present the time-domain synchronization algorithm divided in three parts.

The algorithm presented on this subsection is based on the algorithms developed by Beek and the subsystem created for its purpose and adapted to the frame pattern on Figure 6 is illustrated in Figure 7. Beek exploits the CP by correlating it with a delayed version of itself. When the repeated pattern is located, a peak is generated in order to detect the frame arrival and the phase between patterns gives the CFO.

The algorithm consists of two main branches. The top one calculates an energy term. While the bottom one calculates the correlation term required for estimating both symbol arrival time and phase offset. Equation (4) shows the calculation of the energy term and equation (5) shows the calculation of the correlation term.

$$ms1 \equiv \frac{\rho}{2} \sum_{k=m}^{m+L+1} |r(k)|^2 + |r(k+N)|^2 \quad (3)$$

$$ms2 \equiv \frac{\rho}{2} \sum_{k=m}^{m+L+1} r(k)r^*(k+N) \quad (4)$$

Channel estimation has always been present in wireless communications systems to assist the receiver in mitigating the effects of the wireless multipath channel on the received signal. In OFDM systems, the acquisition of

accurate (CSI) is crucial to achieve high spectral efficiency, with emphasis on the demodulation/decoding process, where the frequency response of the channel at the individual subcarrier frequencies needs to be accurately estimated to be used in the decoding process. Furthermore, the synchronization algorithm presents a phase offset ambiguity after frequency offset correction that must be estimated by the channel estimator and removed in the equalization process.

The system discussed in this paper uses the common rectangular pilot pattern adopted by the LTE standard with some adaptations, where a 12 symbol OFDM frame carries pilots in the 1st, 5th and 9th symbol. The pilot-carrying subcarriers are optimally equipowered and equidistant to achieve the lowest mean square error (MSE) [18][19], considering that the transceiver uses LS channel estimation.

The distance between consecutive pilots is 6 subcarriers. The first and last 208 subcarriers are not loaded making-up the band guards on each end of the spectrum to contain the spectral leakage typical of OFDM systems. An initial ZC training symbol is appended to the frame for synchronization. The frame structure is depicted in Figure 6.

This pilot arrangement has been extensively used in the related literature. Some of the outstanding works on channel estimation that used it can be found in [20][21][22]

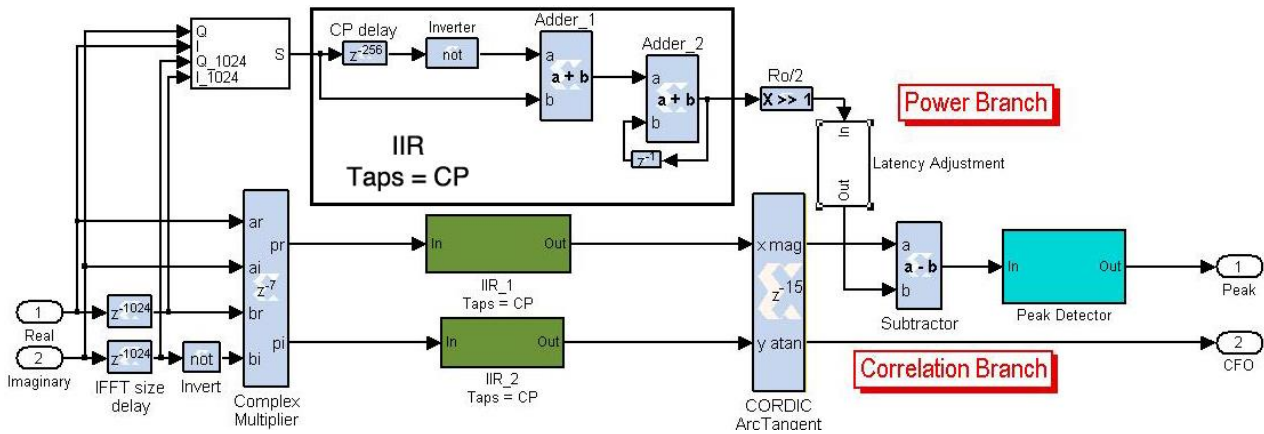

Fig. 4. Beek estimation algorithm implementation on Xilinx System Generator for DSP

To overcome the issue of having to extrapolate the edge subcarriers [23][24], with the subsequent degradation of the estimation accuracy, the adopted frame structure has pilots at both edge subcarriers.

In this work, the initial estimate in the pilot subcarriers used the well-known LS estimator [25]. This classical estimator does not take

implementation complexity, requiring only an inversion and a multiplication per pilot subcarrier. Considering that the value received in the k th pilot subcarrier $p(k)$ can be expressed by

$$u(k) = s(k)h(k) + n(k) \tag{5}$$

where $h(k)$ is the channel value affecting the k th pilot subcarrier. The LS estimation's output can be expressed as

$$\hat{h}(k) = \frac{p(k)}{s(k)} = h(k) + \frac{n(k)}{s(k)} \tag{6}$$

that can be interpreted as noisy samples of the wanted channel frequency response (CFR).

In the literature, some channel estimation schemes output the full channel estimate (for both data and pilot subcarriers) [20], but our initial estimation only outputs the channel values for the pilot subcarriers. It is now necessary to estimate the channel values for the data-carrying subcarriers. The simplest method would be to extend the current channel estimates to the closest pilots in both frequency and time domains [26]. This method only yields acceptable performance if the correlation of the CFR for neighbouring pilots is significant. Therefore, it is only adequate for scenarios where the channel varies slowly and has a limited delay spread. The transceiver introduced in this paper adopted a linear interpolation method in the frequency domain, similar to the

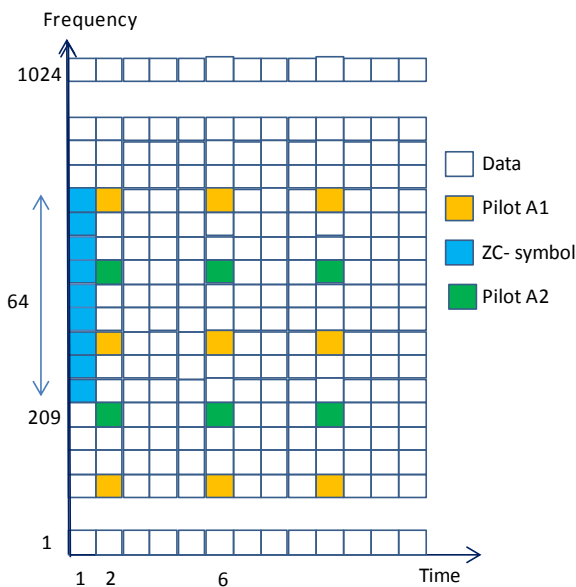

Fig.5 Frame format two antennas

advantage of the correlation of the channel across the subcarriers in frequency and time domains nor does it use a-priori information on the channel statistics to obtain the estimate, but, on the other hand, presents a reduced

one found in [27][28], using a first order polynomial to define the line that connects two neighbouring pilots, enhancing the performance of the previous scheme [29]. Higher order polynomials could be used [30]-[32] to achieve higher accuracy in estimating highly selective channels, at the cost of a higher implementation complexity. With the full CFR for the pilot-carrying symbols, and as the pilot separation is small in time domain (4 symbols), the transceiver extends each CFR estimate until next pilot-carrying symbol, to get the full frame CFR.

3 MISO with Alamouti Codification

The following subsections present an implementation of the Alamouti algorithm, using the upgraded SISO HW platform to support the transmission of encoded data signals and decode the received signal. The MIMO systems need pre/post processing the signals for the multiple antennas, in both sides. Alamouti encoding/decoding, appears as being part of the transmit diversity, in this way not providing higher data rate, but conferring link robustness without increasing total transmission power or bandwidth. For two transmitting antennas and one receiving antenna it is achieved a diversity gain of 2 assuming an uncorrelated channel. The code presents a remarkable spatial and time diversity by using a simple code at the transmitter and linear decoding at the receiver, this means low complexity in the receiver.

3.1 Alamouti transceiver

In Fig. 6 it is represented the Alamouti transmitter and receiver diagram. The implementation uses the same HW blocks used to implement the SISO OFDM system to which the Alamouti encoder/decoder blocks have been added. The SISO transmitter is duplicated after the encoder to implement the MISO. The OFDM symbols transmitted which carry pilots to help channel estimation, should have, in each branch, their pilot carriers placed in non-coincident indexes. In one branch pilots occupy every other sixth index position and a zero is transmitted in the middle carrier between two pilots, on the other the branch pilots and zeros are swapped relatively to the other branch. This way, two channels can be estimated in the receiver, using a different set of pilots for each channel.

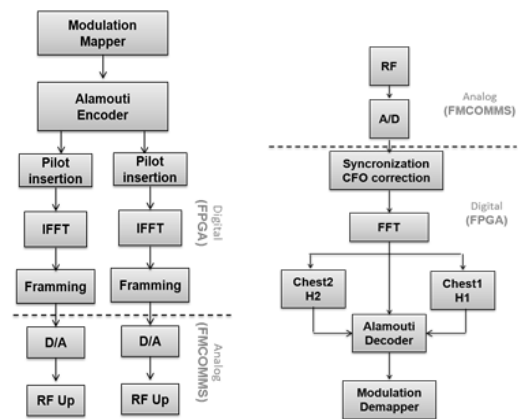

Fig. 6: Alamouti Transceiver Diagram .

As in the transmitter, the Alamouti receiver uses the HW blocks that implement the SISO system. From the ADC to the channel estimator block, MISO and SISO receivers are similar. Time synchronization, CFO estimation CP removal and FFT transformation are common operations in both systems. The MISO system requires that the channel estimation is duplicated. The Alamouti decoding requires that a channel between each transmitting antenna and the receiving antenna to be calculated.

3.2 Alamouti encoder/decoder

The Alamouti coding encompasses two codes namely code 1 and code 2. Code 1 provides the original data on the first antenna, without any modification, being compatible with systems where the second antenna is not implemented or switched off and is the one used in LTE. We will implement original Alamouti code referred as code 2 and represented by Table 1.

TABLE 1 ALAMOUTYI CODE 2

Frequency	Antenna 1	Antenna 2
k	s_k	s_{k+1}
$k+1$	$-s_{k+1}^*$	s_k^*

The implementation of the code requires that the data time sequence between two paired symbols to be swapped. This is done by the circuit represented in Fig. 7. Two symbol sequences are created with one delayed relatively to the other. Than the two sequences are sampled alternatively using a multiplexer. This is simple way two change the time

order of consecutive pairs of symbols. The counter counts between on and zero, synchronized with the data. The other mathematical operation required is the conjugate.

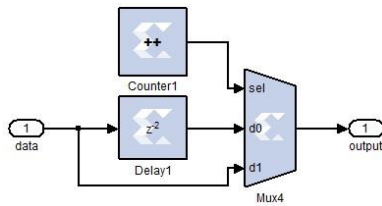

Fig. 7: Circuit to reverse two symbols time sequence.

The estimated block symbols, in the frequency domain (i.e., after cyclic prefix removal and FFT), are given by

$$\tilde{s}_k = \hat{h}_{1,k+1}^* r_k + h_{2,k} r_k^* \tag{7}$$

$$\tilde{s}_{k+1} = -h_{1,k} r_{k+1}^* + h_{2,k+1}^* r_{1,k} \tag{8}$$

where $h_{1,k}$ and $h_{2,k}$ represents the Rayleigh flat fading channel between antennas 1, 2 and the receiver, respectively, on the k th subcarrier.

The Alamouti decoding besides requiring channel estimation it also requires conjugate and complex multiplications.

3.3 The channel estimation

Channel estimation is required to decode the received signal in the Alamouti scheme. The channel estimation requires that the transmission between antenna 1 and the receiver and antenna 2 and receiver is required. The channel is estimated using reference symbols, pilots QPSK modulated.

The pilots reference subcarriers occupy in the symbol an index position that are used in LTE. The pilots subcarriers for one transmitting antenna are set to zero in symbol to be transmitted by the other antenna. Relative index for the pilot subcarriers are displaced by two positions. This way when one antenna is transmitting pilots the other antenna is transmitting a null which allow the channel can be estimated between transmitting antennas and receivers.

4 Numerical results

To teste the platform model a scenario of a MISO SDR system was set up in the platform. The MISO consisted of two transmitting antennas and a receiving antenna. The transmitter was configured to implement the Alamouti scheme. The channels between transmitting antennas and receiving antenna have been implemented in Simulink/matlab to model a Rayleigh channel with two paths each. The filter coefficients have been obtained with matlab functions.

Several configurations have been assumed. First in a system model implemented in matlab it was obtained the bit error rate (BER) for a pure additive white Gaussian noise channel. In a second scenario we simulated the use of a single transmitting antenna and a single receiving antenna. The channel was one of Rayleigh channels. In a third scenario a second antenna was also transmitting and a Rayleigh channel was implemented between this antenna and the receiving antenna, the signal transmitted antenna. The multipath channel coefficients use are:

$$Ca1 = -0.3 + j1.0, \quad Ca2 = 0.096 - j0.96$$

From transmitting antenna 1 to receiving antenna

$$Cb1 = 1.05 + j 0.65 \quad Cb2 = -0.05 + j0.356$$

From transmitting antenna 2 to receiving antenna

The delay spread between the two complex coefficients for each channel is 50 μ s.

In figure 8 we present the numerical results obtained from the simulations

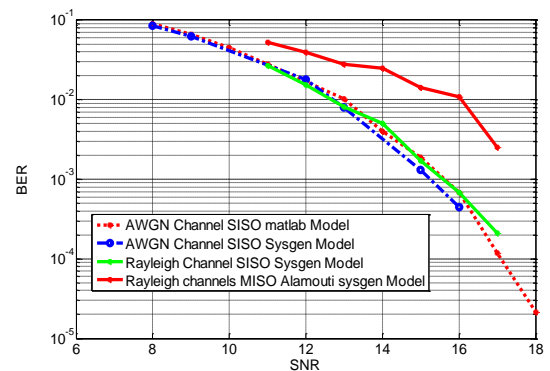

Fig. 8: Numerical results with platform configured for MISO Alamouti scheme compared with SISO scheme

The MISO system follows the Gaussian channel because the combination of the channels improves the performance compared to the SISO system. In fact during the simulation the channels are static, they don't vary from frame to frame.

5 Testbed HW Platform

Our hardware testbed platform uses two Xilinx ML605 development boards, one implements the transmitter the other implements the baseband receiver. The baseband dual antenna transmitter module connects with the analog RF transceivers via LPC and HPC FMC interfaces.

The RF boards are the FMCOMMS1-EBZ high speed analogue modules, which include DAC/ADC, IQ modulator/demodulator, RF up/down conversion.

TABLE 2 SYSTEM PARAMETERS

System Parameters	
Baseband frequency Bandwidth	15.36 MHz 10 MHz
FFT size CP size	1024 256
Modulation	QPSK
Subcarrier separation	15 kHz
Symbol duration (Symbol+CP)	66.66 + 16.66 = 83.32 μ s
Oscillator frequency	7.68 MHz

The tests have been performed at 2.4 GHz and the two channels have been combined using a power combiner. Even though the targeted standard is LTE, such implementation can be adapted to several

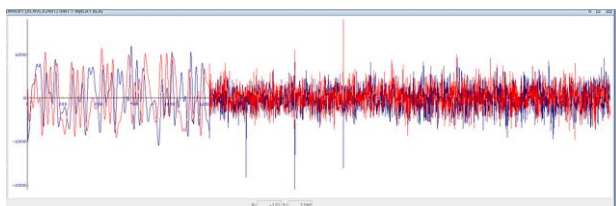

Fig. 9: I/Q time domain signal at the input.

OFDM standards such as 802.11a, WiMAX, given the configurability of the parameters. The system parameters are presented in table 2 and follow closely an LTE design. In this work we focused on QPSK modulation and used 1024 FFT carriers

The OFDM symbol that is used in our test considers 600 useful carriers from 1024, the FFT

size, the remaining carriers are set to zero. The frame has 7 symbols. The first one carries a Zadoff-Chou sequence occupying 72 carriers, in the center of the spectrum. The second OFDM symbol, as well as the fifth symbols, contains pilots and data. The remaining OFDM symbols are for data only.

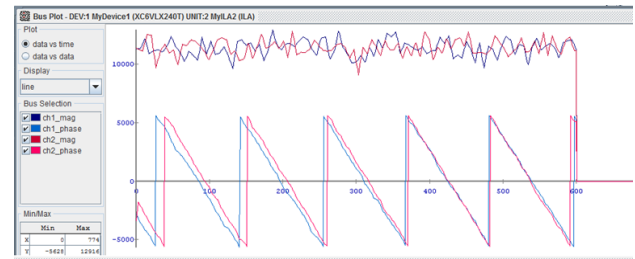

Fig. 10: OFDM symbol with a 6 kHz offset between oscillators. Before compensation (left) and after compensation (right).

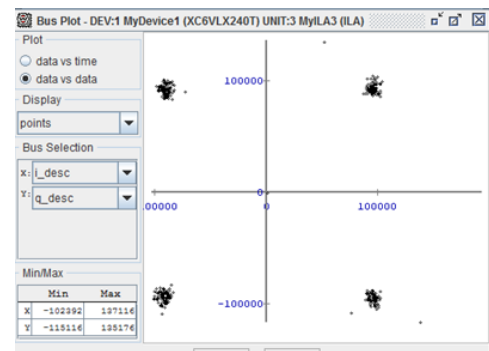

Fig. 11: Recovered QPSK Constellation after decoding and equalization.

The frame configuration is defined in the compilation phase with the data to the ROM matrix being calculated using Matlab. The tests were performed in a wired-channel and the system was run at a system clock of 61.44 MHz. The results were obtained using the Xilinx ChipScope Pro tool. The number of symbols in a frame and its sequence type can be extended by coding a vector that represents frame organization.

6 Test Results

Several tests have been performed to validate the algorithms and transceivers implemented in the FPGA. First simulation using system generator for DSP and Simulink to check the algorithm working as expected. To simulate the channels between the transmitting antennas and the receiver we used cables with different lengths and a power combiner.

This way we have a more controlled scenario for testing. Fig. 9 shows part of a signal frame, recovered at the receiver baseband input (ADC output). This signal combines the two transmitted signals reaching the receiver. The peaks are due to the frequency pilots which we consider all equal to one, only for testing purposes, in the future they will be generated to minimize the (peak to average power rate) PAPR. The first symbol represents a Zadoff Chou sequence the second symbol carries pilots and the three following symbols are data symbols.

Fig. 10 shows the estimated and interpolated channels, phase and amplitude, Antenna1 to receiver and antenna 2 to receiver. The results show a flat response in magnitude and a linear phase as expected.

In Fig. 11 a fully recovered constellation proves that encoding and decoding are working properly.

7 Conclusions and Future Work

We were able to develop and implement in an FPGA a fully Alamouti scheme including RF transmission in the testing chain

Although the Alamouti scheme conceptually is simple, its implementation in HW requires that control data paths and data processing for channel estimation to be properly designed in order to decoding is properly done. These processing techniques can be extended to other coding schemes, reducing the design time to implementation.

This work will continue to include in cooperation between transmitters. Future work will be to implement the functionalities that will allow precoding schemes. It requires the knowledge, by the transmitter, of the channel response. We will be looking for architectures to include this feature in the chain, well as developing precoding processing blocks.

Acknowledgment :

This work was supported by the Portuguese Fundação para a Ciência e Tecnologia (FCT) COPWIN (PTDC/EEI-TEL/1417/2012), ADIN (PTDC/EEI-TEL/2990/2012) and HETCOP (PEst-OE/EEI/LA0008/2013) projects.

References:

- [1] Hui Liu and Guoqing Li, *OFDM-Based Broadband Wireless Networks*, John Wiley & Sons, Inc., 2005.
- [2] 3GPP TS 36.201 V8.1.0, 3rd Generation Partnership Project; Technical Specification Group Radio Access Network; Evolved Universal Terrestrial Radio Access (E-UTRA); LTE Physical Layer - General Description, Nov. 2007.
- [3] G.J. Foschini and M.J. Gans, "On limits of wireless communications in a fading environment when using multiple antennas", *Wireless Personal Communications Magazine*, vol. 6, no. 3, Mar. 1998.
- [4] S. M. Alamouti, "A Simple Transmit Diversity Technique for Wireless Communications", *IEEE Journal on Selected Areas in Communications*, vol. 16, pp.1451-1458, Oct. 1998.
- [5] Anou Abderrahmane, Mehdi Merouane, Bensebti Messaoud, "Diversity Techniques to combat fading in WiMAX", in *WSEAS Transactions on Communications*, Issue 2, Volume 7, February 2008, pp.43-51
- [6] Stefan Kaiser, "Space Frequency Block Coding and Code Division Multiplexing in OFDM Systems", *IEEE Proceedings of GLOBECOM*, 2003.
- [7] M. Majó, "Design and implementation of an OFDM-based communication system for the GNU radio platform", Master Thesis, Dec. 2009.
- [8] A. Marwanto, M. A. Sarijari, N. Fisal, S. K. S. Yusof, and R. A. Rashid, "Experimental study of OFDM implementation utilizing GNU Radio and USRP - SDR", *Proc. of the IEEE 9th Malaysia International Conference on Communicatons*, Dec. 2009, pp. 132-135.
- [9] P. Murphy, A. Sabharwal, and B. Aazhang, "Design of WARP: a wireless open-access research platform", *Proc. of the European Signal Processing Conference*, Sept. 2006, Article No. 7.
- [10] P. Murphy, A. Sabharwal, and B. Aazhang, "On building a cooperative communication system: testbed implementation and first results", *EURASIP Journal on Wireless Communications and Networking*, June 2009, doi:10.1155/2009/972739.
- [11] J. Garcia and R. Cumpulido, "On the design of an FPGA-based OFDM modulator for IEEE 802.11a", *2nd International Conference on Electrical and Electronics Engineering*, Sept. 2005, pp. 114-117.

- [12] J. Garcia and R. Cumplido, "On the design of an FPGA-based OFDM modulator for IEEE 802.16-2004", 2005 International Conference on Reconfigurable Computing and FPGAs, 2005, pp. 22-25.
- [13] Albert A. Lysko, David L. Johnson, "A Study of Propagation Effects in a Wireless Test Bed", in WSEAS Transactions on Communications, Issue 8, Volume 7, August 2008, pp.857-871
- [14] S. Syed Ameer Abbas, S. J. Thiruvengadam, "Fpga Implementation Of 3GPP-Lte Physical Downlinkcontrol Channel Using Diversity Techniques", in WSEAS Transactions On Signal Processing, Issue 2, Volume 9, April 2013, pp 84-97
- [15] T. Pereira; Violas, M.; J.L. Lourenço; Gameiro, A.; Silva, A. ; Ribeiro, C.; "An FPGA Implementation of OFDM Transceiver for LTE Applications", Intrnl. Journal On Advances in Systems and Measurements, Vol. 6, No. 1-2, pp. 224 - 234, June, 2013.
- [16] P. Moose, "A technique for Orthogonal Frequency Division Multiplexing frequency offset correction", IEEE Transactions on Communications, vol. 42 no. 10, pp. 2908-2914, October 1984.
- [17] Jan-Jaap van de Beek, M. Sandell, and P. O. Börjesson, "ML estimation of time and frequency offset in OFDM systems", IEEE Transactions on Signal Processing, vol. 45, no. 7, July 1997.
- [18] T.M. Schmidl and Cox, and D. C. Cox, "Robust frequency and timing synchronization for OFDM", IEEE Transactions on Communications, vol. 45, pp. 1613-1621, December 1997.
- [19] R. Negi, and J. Cioffi, "Pilot tone selection for channel estimation in a mobile OFDM system", Journal IEEE Transactions on Consumer Electronics, pp. 1122-1128, vol. 44 issue 3, August 1998, doi: 10.1109/30.713244.
- [20] I. Barhumi, G. Leus, M. Moonen, "Optimal Training Design For Mimo-Ofdm Systems in Mobile Wireless Channels", IEEE Transactions on Signal Processing, vol. 51 no. 6, pp. 1615-1624, June 2003.
- [21] P. Hoehner, S. Kaiser, P. Robertson, "Two-dimensional pilot-symbol-aided channel estimation by Wiener filtering," in Proceedings of IEEE International Conference on Acoustics, Speech, and Signal Processing, pp. 1845-1848, April 1997.
- [22] [S. Kaiser, P. Hoehner, "Performance of multi-carrier CDMA systems with channel estimation in two dimensions," in Proc. IEEE Personal, Indoor and Mobile Radio Communications Symposium, pp. 115-119, Helsinki, Finland, September 1997.
- [23] Y. Li, "Pilot-symbol-aided channel estimation for OFDM in wireless systems," IEEE Transactions on Vehicular Technology, Vol. 49, Issue 4, pp.1207-1215, July 2000.
- [24] S. Boumard, A. Mammela, "Channel Estimation Versus Equalization in an OFDM WLAN System," in Proc. IEEE Vehicular Technology Conference, vol. 1, pp. 653-657, Rhodes, Greece, May 2001. [47] S. Boumard, A. Mammela, "Channel Estimation Versus Equalization in an OFDM WLAN System," in Proc. IEEE Vehicular Technology Conference, vol. 1, pp. 653-657, Rhodes, Greece, May 2001.
- [25] M. Shin, H. Lee, C. Lee, "Enhanced Channel Estimation Technique for MIMO-OFDM Systems," IEEE Transactions on Vehicular Technology, vol. 53, no. 1, pp. 261-265, Jan. 2004.
- [26] A. Chini, "Multicarrier modulation in frequency selective fading channels," Ph.D. dissertation, Carleton University, Canada, 1994.
- [27] J. Rinne, M. Renfors, "Pilot spacing in Orthogonal Frequency Division Multiplexing systems on practical channels," IEEE Transactions on Consumer Electronics, vol. 42 no. 3, pp. 959 - 962, November 1996.
- [28] S. Coleri, M. Ergen, A. Puri, A. Bahai, "Channel Estimation Techniques Based on Pilot Arrangement in OFDM Systems," IEEE Transactions on Broadcasting, vol. 48, no. 3, pp. 223-229, Sept. 2002.
- [29] C. Athaudage, A. Jayalath, "Low-Complexity Channel Estimation for Wireless OFDM Systems," in Proc. IEEE International Symposium on Personal, Indoor and Mobile Radio Communications, vol. 1, pp. 521 - 525, Beijing, China, Sept. 2003.
- [30] S. Coleri, M. Ergen, A. Puri, A. Bahai, "A Study of Channel Estimation in OFDM Systems," in Proc. IEEE Vehicular Technology Conference, vol. 2, pp. 894 - 898, Vancouver, Canada, Sept. 2002.
- [31] X. Wang, K. Liu, "OFDM Channel Estimation Based on Time-Frequency Polynomial Model of Fading Multipath Channel," in Proc. IEEE Vehicular Technology Conference, vol. 1, pp. 460 - 464, Atlantic City, USA, Oct. 2001.
- [32] A. Dowler, A. Doufexi, A. Nix, "Performance Evaluation of Channel Estimation Techniques for a Mobile Fourth Generation Wide Area

OFDM System,” in Proc. IEEE Vehicular Technology Conference, vol. 4, pp. 2036 – 2040, Vancouver, Canada, Sept. 2002.

- [33] S. Lee, D. Lee, H. Choi, “Performance Comparison of Space-Time Codes and Channel Estimation in OFDM Systems with Transmit Diversity for Wireless LANs,” in Proc. Asia-Pacific Conference on Communications, vol. 1, pp. 406 – 410, Penang, Malaysia, Sept. 2003.